



ANTENNA SELECTION GUIDE

CELLULAR | 3G | 4G | 5G | WIFI | BLE | ISM | NB-IoT |
LTE CAT-M | NAVIGATION | DSRC | V2X | LoRa | SIGFOX |

KYOCERA AVX is a leading supplier of active and passive antenna solutions for industrial, commercial, automotive, and medical applications with prototyping facilities in the United States, France & Taiwan, China and manufacturing sites in South Korea, Vietnam, and China. KYOCERA AVX antennas offer a competitive advantage in the market by providing enhanced throughput speed, spectral efficiency, reliability and performance.

Our ever-evolving portfolio consists of antennas, antenna technologies, RF chipsets, antenna systems, and measurement systems for both active and passive antenna solutions.

KYOCERA AVX STATE-OF-THE-ART MANUFACTURING CAPABILITIES

- Stamping
- LTCC
- Plastic injection molding
- Heat-staking
- Plasma treatment
- FR4 and Composite material
- Acoustic module design and testing (THD, SPL)
- Flexible printed circuit
- PAD printing, painting
- Laser Direct Structuring (LDS)
- Cable assemblies
- RF testing
- HTC ceramic
- Chemical plating
- Wired antenna forming



2.5B

Antenna solutions sold and shipped to market



212

Patents and continued IP portfolio growth



3000

Platforms designed with leading customers



300

Active and passive antenna products



5

Global Design Centers



24

Antenna Measurement Systems



1st

World's Leading Automotive Test Chamber

KYOCERA AVX antennas are designed for a wide array of applications. Whether the antenna is embedded, internal, external, or outdoor, KYOCERA AVX uses its worldwide manufacturing capabilities to provide state of the art antenna technology. The KYOCERA AVX Antenna Design team helps customers select the best antenna for the application.



Internet of Things



Industrial



Automotive



Lighting



Narrow Band
Internet of Things



Cellular
4G / 5G



Smart Homes
& Cities



Infotainment &
Navigation



Electric Vehicles
& Stations



Payment
Terminals



Fleet & Asset
Tracking



Satellite
Communications



Near Field
Communication



Smart Meters



DSRC / V2X



Security



Agriculture

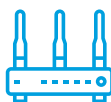

Gateway Routers



Consumer



Medical



1 | CONSULTATION

- Definition of critical electrical/mechanical performance requirements
- Feasibility study and CAD/board layout review
- Recommendations on antenna technology, placement and orientation



2 | DESIGN

- Antenna Selection: Standard vs. Custom, Active vs. Passive, etc.
- Reference design integration experience
- Mechanical engineering optimization
- RF simulations
- Design for industrialization



3 | PROTOTYPING

- Prototyping tools (3D printers, LPKF machines, fully equipped workshops)
- Mock-ups to validate technical offering
- Samples



4 | TEST & OPTIMIZATION

- Pre-Certification testing reports for FCC, PTCRB, EMI, Noise issues
- Available tests: VNA & Anechoic Chamber Testing, Octobox Chamber Measurements, Device Simulation, Test House Measurements, Benchmark Testing & Competitive Analysis



5 | MANUFACTURING

- Quality documentation available
- 4 antenna manufacturing locations
- More than 2.5Bn antennas in the market

Connectivity is key in today's world and devices in the market require strong signal strength to allow for peak performance. Integrating an antenna is not trivial, whether it is an off-the-shelf product or a highly customized solution, and should not be an afterthought.

The KYOCERA AVX Antenna Design Team strongly recommends considering the antenna design and/or the antenna integration process as early as possible, ideally during the product design and the radio module selection. A perfect match between the radio and the antenna will ensure all wireless connectivity needs are met.

Working with the KYOCERA AVX Antenna Design Team is simple and straight forward. The team will ask relevant questions to determine if a standard, off-the-shelf antenna or a customized antenna is the best technology solution.

If a standard antenna is necessary, please refer to the links below for integration documentation:

- Datasheets: <http://www.kyocera-avx.com/antennas>
- Application Notes, DXF files & ME-FIT (3D CAD) (*found under specific individual antenna product pages*)
- Stock check: www.kyocera-avx.com/resources/distributor-stock-check

If a customized passive or active antenna is necessary, the KYOCERA AVX Antenna Design Team will contact and work with the key partners (distribution, sales, design, FAE, etc.) to fully understand the overall challenge and offer the best technology solution.

For questions and additional information about our solutions, please contact the KYOCERA AVX Antenna Design Team.

KYOCERA AVX ANTENNAS AMERICAS
eth.usasales@kyocera-avx.com

KYOCERA AVX ANTENNAS EUROPE
eth.europesales@kyocera-avx.com

KYOCERA AVX ANTENNAS ASIA
eth.asiasales@kyocera-avx.com

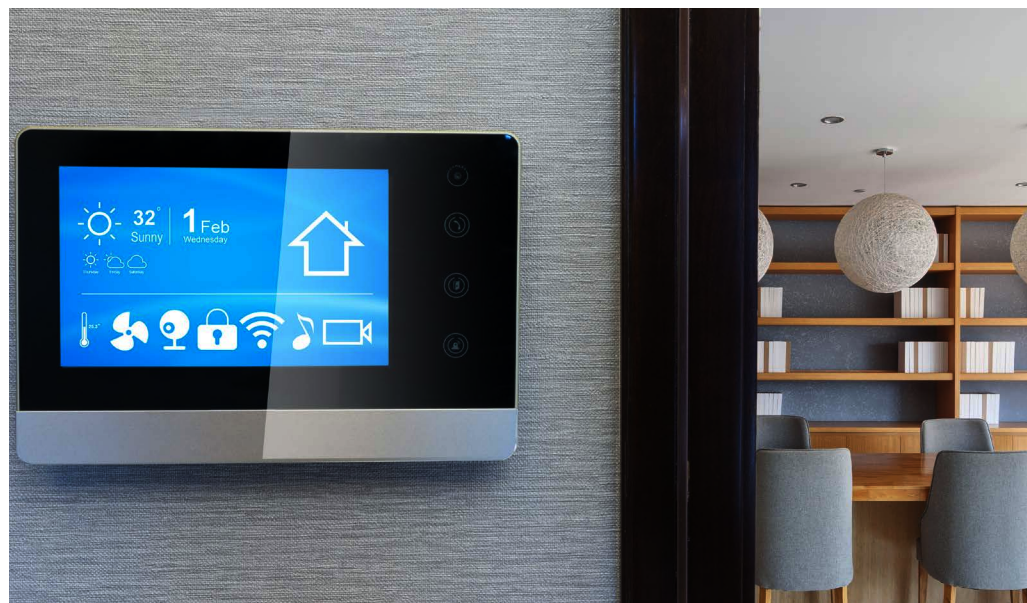

IS THIS A NEW DEVICE OR AN EXISTING DEVICE TO BE IMPROVED?

Are the mechanics frozen or flexible? Is the antenna location, shape and interconnect solution frozen? Standard antennas have a quicker time to market compared to custom designs making it easier to integrate them into projects, while minimizing redesign cycle time and eliminating design fees. A custom design can be developed to match required electrical and mechanical specifications.

WHAT TYPE OF ANTENNA IS REQUIRED?

- Embedded (on board the device PCB) • Internal (inside device, but not surface mounted)
- External (outside device) • Outdoor (IP67)

WHAT ARE THE MAIN CHALLENGES FOR THIS PROJECT?

KYOCERA AVX offers testing, debugging, designing, and manufacturing to solve challenges including:

- RF specifications • ME specifications • Design layout • Antenna integration • Surrounding interference, etc.

IS A SPECIFIC STANDARD REQUIRED?

- Automotive (PPAP and IATF16949) • High reliability (MIL-PRF, T-Space, SRC9000, etc.)
- IP rating • UL rating • Plenum rating, etc.

WHAT ARE THE ANTENNA SURROUNDINGS?

- Metallic components (heat sink, connectors, battery, big cap) • Additional antennas • Wires • Flexible FPC
- Audio components (speaker, microphone, earpiece) • High speed digital traces • Specific ground layout
- Shield boxes • Material loading close • Human body (hand, head, body worn device) • Potting material
- Nearby power components • 50 Ohms line to antenna

WHAT IS THE DESIRED FREQUENCY RANGE, MAXIMUM VOLUME AND LOCATION?

Are the electrical and mechanical specifications available, and what is the selected antenna module? When a bigger antenna volume is available, better performances can be expected. The KYOCERA AVX Antenna Design Team will suggest the most optimized antenna shape, dimensions, and location based on the product to be developed.

WHAT TYPE OF MOUNTING IS REQUIRED?

- RF cable & connector • SMT • Mag mount • Adhesive mount • Screw mount • Off-board • Pogo pin
- C-clips (spring contacts) • One-ended soldered cable

WHAT TYPE OF CONNECTOR IS REQUIRED?

- SMA • RP-SMA • TNC • RP-TNC • U.fl • W.fl • Fakra • MMCX • BNC • N • NMO

WHAT TYPE OF CABLE IS REQUIRED?

- Micro coaxial 0.8mm, 1.13mm, or 1.37mm diameter • RG58 • RG174 • RG316 • LMR200 • LMR400
- LMR195 • LMR240

FOR AN EMBEDDED SOLUTION, IS PCB CLEARANCE POSSIBLE?

Is the PCB layout available to optimize the distance between the radio and the antenna, and the space from any threatening surroundings?

ARE THE PCB LAYOUTS & 3D GERBER FILES AVAILABLE?

Helps to define a better antenna placement based on the surroundings and the PCB/product structure

TEST	DESIGN	DELIVERABLE
<p>LDS-001 Cellular / LTE / 4G</p>	<p>PHASE 1 Passive Study (Feasibility Study)</p> <ul style="list-style-type: none"> • Development of prototype • Tuning, matching, & optimization • Antenna measurement: efficiency, peak gain, radiation pattern (one frequency by band) <p>PHASE 2 Real Environment Test (Main Board / Near Human Body)</p> <ul style="list-style-type: none"> • Tuning, matching adjustment • Antenna measurement: return loss, peak gain, efficiency, radiation pattern 	<p>RF Report:</p> <ul style="list-style-type: none"> • Antenna configuration in chamber • Antenna testing result <p>Mechanical recommendations to optimize the performance</p>
<p>LDS-002 Cellular / LTE / 4G</p>	<p>Active Testing</p> <ul style="list-style-type: none"> • TRP / TIS (Channel to define) • RF tuning in active mode 	<p>Full characterization, measurement & analysis of antenna device performance</p> <p>RF Report</p>
<p>LDS-003 Available for Any Application</p>	<p>RF simulations for antenna parametric study</p>	<p>Full characterization based on a given environment</p>



TEST	DESIGN	DELIVERABLE
GDS-001 Global Navigation System	PHASE 1 Passive Study (Feasibility Study) <ul style="list-style-type: none"> • Development of prototype • Tuning, matching, & optimization • Antenna measurement: efficiency, RL/ VSWR, peak gain, radiation pattern, axial ratio PHASE 2 Real Environment Test (Main Board / Near Human Body) <ul style="list-style-type: none"> • Tuning, matching adjustment • Antenna measurement: return loss, peak gain, efficiency, radiation pattern, VSWR 	RF Report: <ul style="list-style-type: none"> • Antenna configuration in chamber • Antenna testing result Mechanical recommendations to optimize the performance
GDS-002 Global Navigation System	Active Study <ul style="list-style-type: none"> • Receive sensitivity • RF Tuning in active mode • RF measurement of full system LNA/ antenna • Noise figure • Gain 	RF Report: <ul style="list-style-type: none"> • Antenna configuration in chamber • Antenna testing result
IDS-001 LoRa / ISM / Sigfox	Design & Testing <ul style="list-style-type: none"> • Tuning, matching adjustment • Antenna measurement: efficiency, peak gain, radiation pattern, RL, VSWR 	RF Report: <ul style="list-style-type: none"> • Antenna configuration in chamber • Raw data
IDS-002 LoRa / ISM / Sigfox	Active testing using CW or active signaling testing	RF Report: <ul style="list-style-type: none"> • Power radiation pattern • Power peak detection



CELLULAR 4G 5G LTE	PART NUMBER	DESCRIPTION	FREQUENCY BANDS
	P822601 / P822602**	FR4 – SMT	698 – 960 MHz & 1710 – 2700 MHz
	1004795 / 1004796**		
	1002436	FR4 – On Board	
	1002089	FR4 – Off Board with SMA Connector	
	1003657	FR4 – Off Board	
	1002292	FPC – Off Board	
	1002289		
	1004112	External – Indoor	
	1004239-001	External Combo w/2 Cables	
	X9001248	External – Mag Mount (IP65)	
	X9000984	External – Indoor	790 – 960 MHz & 1710 – 2700 MHz
	X9001376	External – Outdoor (IP67)	
	X1005246	External – Outdoor	698 – 960 MHz 1710 – 2170 MHz 2300 – 2690 MHz
	X1005324	External – Outdoor	698 – 960 MHz 1710 – 2170 MHz 2300 – 2690 MHz
	X1005245	External – Outdoor	698 – 960 MHz 1710 – 2170 MHz 2300 – 2690 MHz 1710 – 2700 MHz
X1005244	External – Outdoor	698 – 960 MHz 1710 – 2170 MHz 2300 – 2690 MHz 1710 – 2700 MHz	
X1005243	External – Outdoor	698 – 960 MHz 1710 – 2170 MHz 2300 – 2690 MHz 1710 – 2700 MHz	
X1005249	External – Outdoor	698 – 960 MHz 1710 – 2170 MHz 2300 – 2690 MHz	

600 MHz	PART NUMBER	DESCRIPTION	FREQUENCY BANDS
	1004795* / 1004796**	SMT – FR4	617 – 960 MHz & 1710 – 2700 MHz

5G / SUB 6GHz CBRS	PART NUMBER	DESCRIPTION	FREQUENCY BANDS
	1000146*	Stamping – On Board	3.3 – 3.8 GHz

	PART NUMBER	DESCRIPTION	FREQUENCY BANDS
2G / 3G	P522304 / 9000154**	FR4 – SMT	824 – 960 MHz & 1710 – 2170 MHz
	LSP69001299TR*	FR4 – SMT Ideal for small form factor PCB 60x40mm, Middle Feed Point	698 – 960 MHz & 710 – 2170 MHz
	X1005324	LTE MIMO / GNSS (active) / WiFi MIMO 5-in-1 External Antenna	698 – 960 MHz 1710 – 2170 MHz 2300 – 2690 MHz
	X1005245	LTE MIMO 3-in-1 External Antenna	698 – 960 MHz 1710 – 2170 MHz 2300 – 2690 MHz 1710 – 2700 MHz
	X1005244	GNSS (active) / LTE / WiFi 3-in-1 External Antenna	698 – 960 MHz 1710 – 2170 MHz 2300 – 2690 MHz 1710 – 2700 MHz
	X1005243	GPS/GLONASS (Active) & LTE 2-in-1 External Antenna	698 – 960 MHz 1710 – 2170 MHz 2300 – 2690 MHz 1710 – 2700 MHz
	X1005249	GPS/GLONASS (active) & LTE 2-in-1 External Antenna	698 – 960 MHz 1710 – 2170 MHz 2300 – 2690 MHz

*Special tuning indicated in the datasheet or app notes | **Mirrored parts are used when antenna feed location needs to be reversed

	SMT ON BOARD		OFF BOARD		EXTERNAL	
	FR4	METAL	FR4	FPC	INDOOR	OUTDOOR
CELLULAR						
4G	P822601 P822602 1002436 1004795 1004796		1002089 1003657	1002292 1002289	1004112 1004239-001 X9000984	X9001376 X9001248 X1005324 X1005245 X1005243 X1005249 X1005244 X1005246
5G						
LTE						
600 MHz	1004795					
5G SUB 6GHz		1000146				
CBRS						
2G	P522304 9000154 LSP69001299TR					X1005324 X1005245 X1005243 X1005249
3G						



2G / 3G / 4G / 5G / LTE APPLICATIONS

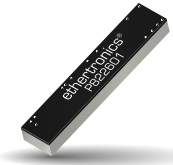

P822601 / P822602 | Embedded Universal Broadband FR4 LTE/Cellular Antenna

Frequency (MHz)	Peak Gain (dBi)	Efficiency	VSWR	Size L x W x H (mm)	GND Plane Size (mm)
698 – 960	2.6	68%	< 2.5:1	49.6 x 8.0 x 3.2	140 x 50
1710 – 2200	4.4	76%			
2500 – 2700	3.4	52%			

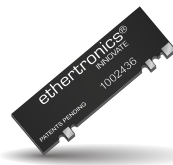

1002436 | Vertical Wideband FR4 Embedded LTE/Cellular Antenna

Frequency (MHz)	Peak Gain (dBi)	Efficiency	VSWR	Size L x W x H (mm)	GND Plane Size (mm)
698 – 960	2.3	69%	< 3.5:1	50.6 x 19.6 x 1.6	120 x 50
1710 – 2200	3.2	63%	< 2.5:1		
2500 – 2700	3.0	53%			



1002089 | LTE/Cellular PCB Antenna with SMA Connector

Frequency (MHz)	Peak Gain (dBi)	Efficiency	VSWR	Size L x W x H (mm)	GND Plane Size (mm)
698 – 960	5.1	> 50%	< 3.0:1	45.0 x 43.8 x 8.0	200 x 135
1710 – 2200	4.9	> 50%			



1003657 | External Balanced LTE/Cellular Antenna

Frequency (GHz)	Peak Gain (dBi)	Efficiency	VSWR	Size L x W x H (mm)	Other
704 – 746	1.0	45.1%	< 2.5:1	104 x 22 x 4.2	Cable length 218mm, using RG178 Cable and MMCX 90° connector.
746 – 787	1.6	51.4%	< 2.0:1		
1710 – 1755 Tx	3.2	65.8%			
2110 – 2155 Rx	3.4	79.6%			

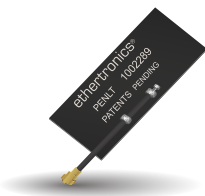

1002289 Series | LTE/Cellular Wide Band FPC Off-Board Antenna

Frequency (MHz)	Efficiency (Long Edge)	Efficiency (Short Edge)	VSWR	Size L x W x H (mm)	GND Plane Size (mm)
698 – 960	74%	67%	< 2.5:1	53.6 x 25.1 x 0.2	140 x 75 Using micro-coaxial cable & u.fl compatible connector
1710 – 2690	58%	63%			

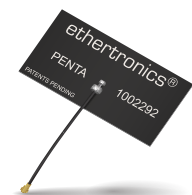

1002292 Series | LTE/Cellular FPC Off-Board Antenna

Frequency (MHz)	Peak Gain (dBi)	Efficiency	VSWR	Size L x W x H (mm)	GND Plane Size (mm)
698 – 960	1.2	50%	< 3.0:1	85.2 x 42.1 x 0.2	110 x 105 Using micro-coaxial cable & u.fl compatible connector
1710 – 2690	5.0	64%	< 2.8:1		

2G / 3G / 4G / 5G / LTE APPLICATIONS



1004112 Series | Broadband External Hinged LTE/Cellular Antenna

Frequency (MHz)	Peak Gain (dBi)	Efficiency	VSWR	Size L x W x H (mm)	Other
698 – 960	1.2	65%	< 2.5:1	218.2 x 27.2 x 13.8	SMA Male: White & Black TNC Male: Black
1710 – 2200	4.5	60%			
2500 – 2700	4.0	78%			



P522304 / 9000154 | Embedded Broadband FR4 2G/3G Antenna

Frequency (MHz)	Peak Gain (dBi)	Efficiency	VSWR	Size L x W x H (mm)	GND Plane Size (mm)
824 – 960	0	62%	< 2.5:1	35.0 x 9.0 x 3.2	110 x 50
1710 – 2170	0.7	55%	< 2.7:1		



1004795 / 1004796 | Embedded Broadband LTE/Cellular FR4 Antenna

Frequency (MHz)	Peak Gain (dBi)	Efficiency	VSWR	Size L x W x H (mm)	Other
698 – 960	1.6	64%	< 2.5:1	36.0 x 9.0 x 3.2	1004796 performance measured on GND Plane size of 125x45mm
1710 – 2200	3.1	55%			
2500 – 2700	1.7	53%	< 3.1:1		



1004239-001 | External Broadband MIMO LTE Antenna

Frequency (MHz)	Peak Gain (dBi)	Efficiency	VSWR	Size L x W x H (mm)	Other
698 – 960	1.6	58%	< 2.5:1	167.0 x 90.0 x 17.2	M4 screw mount; 2 cables LMR-200 equivalent; SMA male, 2m length
1710 – 2200	3.1	61%			
2500 – 2700	1.7	59%	< 3.1:1		



X9001376 Series | External EU 4G/LTE Antenna

Frequency (MHz)	Peak Gain (dBi)	Efficiency	VSWR	Size L x Diameter	Other
790 – 960	1.1	63%	< 5.9:1	180mm x 12.98mm	IP67; RPSMA Connector White & Black
1710 – 2700	2.5	62%	< 2.6:1		



X1005246 | LTE External Antenna

Frequency (MHz)	Peak Gain (dBi)	Efficiency	VSWR	Size L x W x H (mm)	Other
698 – 960	2.8	46%	< 1.8:1	105.1 x 30.1 x 6.7	IPX7; SMA(M) Connector
1710 – 2170	3.1	54%	< 1.5:1		
2300 – 2690	2.7	44%	< 2.0:1		

2G / 3G / 4G / 5G / LTE APPLICATIONS



LSP69001299TR | Embedded FR4 LTE/Cellular Antenna

Frequency (MHz)	Peak Gain (dBi)	Efficiency	VSWR	Size L x W x H (mm)	Other
698 – 960	< -3	15%	< 7.0:1	35.0 x 9.0 x 3.2	Centered feed location for small PCB applications
1710 – 2200	< -1.2	42%	< 5.9:1		

*Performance on GND Plane 60x40mm



X9001248 Series | External Mag Mount LTE/Cellular Antenna

Frequency (MHz)	Peak Gain (dBi)	Efficiency	VSWR	Size L x Diameter	Other
698 – 960	1.8	54%	< 3.2:1	112mm x 29mm	IP65; Magnetic Mount, RG174U; 1-3m Length; SMA Male Connector
1710 – 2700	1.9	36%	< 3.0:1		

*Performance on GND Plane 300x250mm



X9000984 Series | External Hinged EU 4G/LTE Antenna

Frequency (MHz)	Peak Gain (dBi)	Efficiency	VSWR	Size L x Diameter	Other
790 – 960	3.4	> 40%	< 3.6:1	196.0mm x 6.0mm	RP-SMA or SMA (Male) Connector Black or White Color 200 x 200 Gnd Plane Size
1710 – 2170	4.7	> 40%	< 3.0:1		



X1005324 | LTE MIMO / GNSS (active) / WiFi MIMO 5-in-1 External Antenna

Frequency (MHz)	Peak Gain (dBi)	Efficiency	VSWR	Size L x Diameter	Other
698 – 960 MHz	3.8 / 3.5	45 / 49%	3.5:1	63.5mm x 141.98mm	IPX7; SMA(M) Connector
1710 – 2170 MHz	3.9 / 4.9	64 / 67%	2.0:1		
2300 – 2690 MHz	3.7 / 4.1	50 / 51%	2.0:1		



X1005245 | GNSS (active) / LTE MIMO 3-in-1 External Antenna

Frequency (MHz)	Peak Gain (dBi)	Efficiency	VSWR	Size L x W x H (mm)	Other
698 – 960 MHz	3.9 / 4.5	47 / 50%	3.7:1	136.2 x 72.4 x 12.7	IPX7; SMA(M) Connector
1710 – 2170 MHz	4.2 / 3.6	64 / 60%	3.7:1		
2300 – 2690 MHz	3.7 / 2.2	57 / 57%	3.7:1		



X1005243 | GPS/GLONASS (Active) & LTE 2-in-1 External Antenna

Frequency (MHz)	Peak Gain (dBi)	Efficiency	VSWR	Size L x Diameter	Other
698 – 960 MHz	2.7	35%	2.0:1	10.5mm x 51.4mm	IPX5; SMA(M) Connector
1710 – 2170 MHz	1.2	29%	2.0:1		
2300 – 2690 MHz	2.1	30%	2.0:1		

2G / 3G / 4G / 5G / LTE APPLICATIONS



X1005249 | GPS/GLONASS (active) & LTE 2-in-1 External Antenna

Frequency (MHz)	Peak Gain (dBi)	Efficiency	VSWR	Size L x W x H (mm)	Other
698 – 960	3.7	40%	< 5.0:1	55.0 x 55.0 x 20.0	IPX5; SMA(M) Connector
1710 – 2170	3.6	57%	< 3.8:1		
2300 – 2690	3.6	55%	< 2.3:1		

CBRS 3.5 GHz / SUB 6GHz 5G APPLICATIONS



1000146 | Embedded Stamped Metal Antenna

Frequency (GHz)	Peak Gain (dBi)	Efficiency	VSWR	Size L x W x H (mm)
3.3 – 3.8	4.1	76%	< 2.6:1	17.9 x 6.9 x 4.3

600 MHz APPLICATIONS



1004795 / 1004796 | Embedded Broadband LTE/FR4 Antenna

Frequency (MHz)	Peak Gain (dBi)	Efficiency	VSWR	Size L x W x H (mm)	GND Plane Size (mm)
698 – 960	1.6	64%	< 2.5:1	36.0 x 9.0 x 3.2	125 x 45
1710 – 2200	3.1	55%			
2500 – 2700	1.7	53%	< 3.0:1		

TEST	MEASUREMENT	DELIVERABLE
<p>LTS-001 Passive Testing in Anechoic Chamber</p> <p>LTS-001A Passive Testing in Automotive Chamber</p>	<p>Full characterization, measurement & analysis of passive performance</p> <p>Benchmark testing possible</p>	<p>RF Report:</p> <ul style="list-style-type: none"> • 2D & 3D Radiation Pattern Plots • Efficiency • Return Loss • Peak Gain • Isolation
<p>LTS-002 Antenna Optimization & Passive Testing in Anechoic Chamber</p> <p>LTS-002A Antenna Optimization & Passive Testing in Automotive Chamber</p>	<p>Antenna matching & performance optimization</p> <p>Full characterization, measurement & analysis of passive performance</p>	<p>Matching network for the antenna. PCB footprint. Mechanical recommendations.</p> <p>RF Report:</p> <ul style="list-style-type: none"> • 2D & 3D Radiation Pattern Plots • Efficiency • Return Loss • Peak Gain • Isolation
<p>LTS-003 Active Testing in Anechoic Chamber</p> <p>LTS-003A Active Testing in Automotive Chamber</p>	<p>Active tests of the full system</p> <p>Benchmark testing possible</p>	<p>RF Report:</p> <ul style="list-style-type: none"> • TRP • TIS
<p>LTS-004 Antenna Optimization & Active Testing in Anechoic Chamber</p> <p>LTS-004A Antenna Optimization & Active Testing in Automotive Chamber</p>	<p>Active tests of the full system</p> <p>Benchmark testing possible</p>	<p>Recommendations for optimization</p> <p>RF Report:</p> <ul style="list-style-type: none"> • TRP • TIS
<p>LTS-005 RF Simulations</p>	<p>EM simulation for antenna design</p>	<p>Full antenna characterization in a given environment based on customer request</p> <ul style="list-style-type: none"> • Parametric study • Body loading • Antenna placement • Antenna tuning

Automotive testing chamber is recommended for vehicles and also large/heavy devices (e.g. washing machines or parking meters)



	PART NUMBER	DESCRIPTION	FREQUENCY BANDS
2.4GHZ &/OR 5GHZ	1003468	Ceramic Patch 18x18x4 – On Board	2.4GHz
	1001013	FR4 – SMT	
	W1 Family	FR4/FPC – Off Board	
	1003893PT / 1003893FT	FR4/FPC – Off Board (Tunable)	
	1001312	LTCC – SMT	
	M310220		
	M830320		
	1002427	Stamped Metal – SMT	
	1002295	Stamped Metal – SMT Vertical Polarization	
	1002298	Stamped Metal – SMT Vertical Polarization	2.4GHz & 5GHz
	1000146	Stamped Metal – SMT	
	M830520	LTCC – SMT	
	1000423	Stamped Metal – On Ground	
	1000418	Stamped Metal – Off Board	
	1001932FT / 1001932PT	FR4/FPC – Off Board (Tunable)	
	1001435M0	Stamped Metal – Off Board	
	WX Family (A, B, C)	FR4/FPC – Off Board 3 types of radiation patterns	
	X9001091	External – Indoor	
	X9000294		
	1001388 / 1001430	Stamped Metal (L & R) – SMT	5GHz
	1004292PT	FR4 – Off Board (Tunable)	
	1004369PT	FR4 – Off Board (Mixed Polarization HP/VP)	
	W2 Family	FR4/FPC – Off Board	5GHz & 6GHz
			5.925 – 7.125GHz
	W3 Family		2.4GHz & 5.925 – 7.125GHz
			2.4GHz & 5 GHz & 6GHz
	X1005323	WiFi External Antenna	2400 – 2500MHz 5150 – 5825MHz
X1005324	LTE MIMO / GNSS (active) / WiFi MIMO 5-in-1 External Antenna	2400 – 2485 MHz 5150 – 5825 MHz	
X1005244	GNSS (active) / LTE / WiFi 3-in-1 External Antenna	2400 – 2485 MHz 5150 – 5850 MHz	

	PART NUMBER	DESCRIPTION	FREQUENCY BANDS
V2X	9001118	Ceramic Patch 13x13x4 – On Board	5.9 GHz
	1002298	Stamping – On Board Vertical Polarization	
DSRC	X1005323	WiFi External Antenna	2400 – 2500MHz 5150 – 5825MHz
	X1005248	GNSS (active) / DSRC 2-in-1 External Antenna	5850 – 5920MHz

	SMT ON BOARD				OFF BOARD			EXTERNAL	
	FR4	STAMPED METAL	LTCC	CERAMIC PATCH	FR4	FPC	STAMPED METAL	INDOOR	OUTDOOR
2.4 GHZ SINGLE BAND	1001013	1002295 1002427	M830320 M310220 1001312	1003468	W1P Series 1003893PT	W1F Series 1003893FT			
2.4 & 5GHZ DUAL BAND		1000146 1002298	M830520		W3P Series WAP Series WBP Series WCP Series 1001932PT 1003893PT	W3F Series 1001932FT	1000418 1000423 1001435M0	X9001091 X9000294	X1005323 X1005324
5GHz		1001388 1001430			W2P Series 1004292PT 1004369PT	W2F Series			
WIFI 6					W2P Series W3P Series	W2F Series W3F Series			
V2X DSRC		1002298		9001118					X1005323 X1005324 X1005248



802.11 a/b/g/n/ac/ax / WIFI / WLAN / BLUETOOTH / BLE / WIFI 6 / ZIGBEE APPLICATIONS



1001013 | Embedded Single Band SMT On/Off Ground Antenna

Frequency (GHz)	Mounting	Peak Gain (dBi)	Efficiency	VSWR	Size L x W x H (mm)	GND Plane Size (mm)
2.400 – 2.485	Off Ground	2.6	76%	< 1.5:1	15.0 x 3.2 x 3.3	70 x 50
	On Ground	0.7	48%	< 1.8:1		

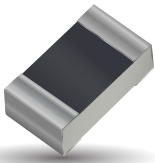

1001312 | Embedded LTCC Single Band Antenna

Frequency (GHz)	Peak Gain (dBi)	Efficiency	VSWR	Size L x W x H (mm)	GND Plane Size (mm)
2.400 – 2.485	1.88	62%	< 1.8:1	2.00 x 1.20 x 0.55	55 x 25



M310220 | Embedded Single Band LTCC Antenna

Frequency (GHz)	Peak Gain (dBi)	Efficiency	VSWR	Size L x W x H (mm)	GND Plane Size (mm)
2.400 – 2.485	1.7	67%	< 2.0:1	3.00 x 1.50 x 1.08	60 x 40



M830320 | Embedded Single Band LTCC Antenna

Frequency (GHz)	Peak Gain (dBi)	Efficiency	VSWR	Size L x W x H (mm)	GND Plane Size (mm)
2.400 – 2.485	1.4	78%	< 2.0:1	8.0 x 3.0 x 1.3	60 x 40



M830520 | Embedded Dual Band LTCC Antenna

Frequency (GHz)	Peak Gain (dBi)	Efficiency	VSWR	Size L x W x H (mm)	GND Plane Size (mm)
2.400 – 2.485	1.0	62%	< 2.1:1	8.0 x 3.0 x 1.3	80 x 40
4.900 – 5.825	2.6	56%	< 2.8:1		



1002298 | Embedded Dual Band Stamped Metal Antenna (Vertical Polarization)

Frequency (GHz)	Peak Gain (dBi)	Efficiency	VSWR	Size L x W x H (mm)	GND Plane Size (mm)
2.400 – 2.485	3.6	78%	< 2.0:1	17.95 x 16.1 x 10.55	75 x 75
4.900 – 5.825	5.1	70%			

802.11 a/b/g/n/ac/ax / WIFI / WLAN / BLUETOOTH / BLE / WIFI 6 / ZIGBEE APPLICATIONS



1002295 | Embedded Single Band Stamped Metal Antenna (Vertical Polarization)

Frequency (GHz)	Peak Gain (dBi)	Efficiency	VSWR	Size L x W x H (mm)	GND Plane Size (mm)
2.400 – 2.485	4.4	79%	< 2.0:1	16.1 x 15.7 x 10.6	75 x 75



1002427 | Embedded Single Band Stamped Metal Antenna

Frequency (GHz)	Peak Gain (dBi)	Efficiency	VSWR	Size L x W x H (mm)	GND Plane Size (mm)
2.450	3.4	61%	< 2.0:1	31.2 x 2.3 x 3.9	110 x 55



1001388 / 1001430 | Embedded 5 GHz Stamped Metal Antenna

Frequency (GHz)	Peak Gain (dBi)	Efficiency	VSWR	Size L x W x H (mm)	GND Plane Size (mm)
5.150 – 5.825	3.5 to 4.5 (Based on location)	72%	< 2.0:1	8.75 x 4.05 x 2.01	75 x 75

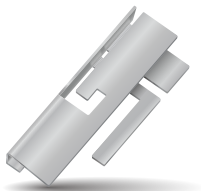

1000146 | Embedded Dual Band Stamped Metal Antenna

Frequency (GHz)	Peak Gain (dBi)	Efficiency	VSWR	Size L x W x H (mm)	GND Plane Size (mm)
2.400 – 2.485	1.5	80%	< 1.5:1	17.9 x 6.9 x 4.3	180 x 120
4.900 – 5.825	2.6	72%	< 1.6:1		

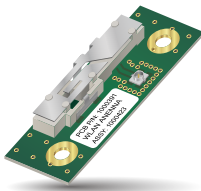

1000423 | Off Board Embedded Dual Band Stamped Metal Antenna (On Ground)

Frequency (GHz)	Peak Gain (dBi)	Efficiency	VSWR	Size L x W x H (mm)	Ref. Coax Length (mm)
2.400 – 2.485	0.6	57%	< 2.5:1	40.0 x 15.0 x 6.4	100
4.900 – 5.825	4.5	75%			

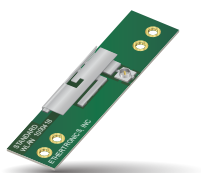

1000418 | Off Board Embedded Dual Band Stamped Metal Antenna

Frequency (GHz)	Peak Gain (dBi)	Efficiency	VSWR	Size L x W x H (mm)
2.400 – 2.485	4.0	70%	< 2.0:1	45 x 11.3 x 5.1
5.150 – 5.825	4.2			

802.11 a/b/g/n/ac/ax / WIFI / WLAN / BLUETOOTH / BLE / WIFI 6 / ZIGBEE APPLICATIONS

1004292PT Series | Tunable Off Board Single Band FR4 5 GHz Dipoles

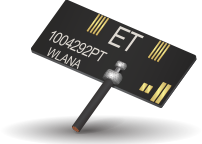

Frequency (GHz)	Peak Gain (dBi)	Efficiency	VSWR	Size L x W x H (mm)	Other
5.150 – 5.850	4.8	70%	< 2.0:1	22.0 x 8.0 x 0.4	Diameter 1.13mm; u.fl compatible connector; Length 100mm using adhesive 3M468

1004369PT Series | Mixed VP/HP Polarized Tunable Off Board Single Band FR4 5 GHz Dipoles

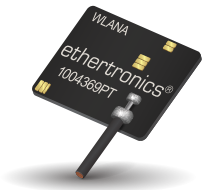

Frequency (GHz)	Peak Gain (dBi)	Efficiency	VSWR	Size L x W x H (mm)	Other
5.150 – 5.850	3.7	76%	< 2.0:1	18.0 x 12.4 x 0.4	Diameter 1.13mm; u.fl compatible connector; Length 100mm using adhesive 3M468

1001932FT Series | Tunable Off Board FPC Dual Band Antenna

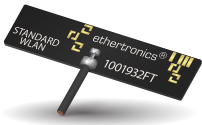

Frequency (GHz)	Peak Gain (dBi)	Efficiency	VSWR	Size L x W x H (mm)	Other
2.400 – 2.485	2.5	60%	< 2.0:1	35.2 x 8.5 x 1.6	Diameter 1.13mm; u.fl compatible connector; Length 100mm using adhesive 3M468
5.150 – 5.825	4.4	71%			

Ideal for last minute tuning in the device by using predefined tuning pads

1001932PT Series | Tunable Off Board FR4 Dual Band Antenna



Frequency (GHz)	Peak Gain (dBi)	Efficiency	VSWR	Size L x W x H (mm)	Other
2.400 – 2.485	2.5	60%	< 2.0:1	35.2 x 8.5 x 1.8	Diameter 1.13mm; u.fl compatible connector; Length 100mm using adhesive 3M468
5.150 – 5.825	4.4	71%			

Ideal for last minute tuning in the device by using predefined tuning pads

1003893FT Series | Tunable High Performance Off Board FPC Single Band Antenna

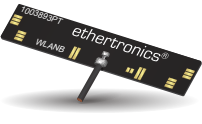

Frequency (GHz)	Peak Gain (dBi)	Efficiency	VSWR	Size L x W x H (mm)	Other
2.400 – 2.485	3.3	87%	< 1.5:1	40.0 x 8.0 x 0.4	Diameter 1.13mm; u.fl compatible connector; Length 100mm using adhesive 3M468

1003893PT Series | Tunable High Performance Off Board FR4 Single Band Antenna

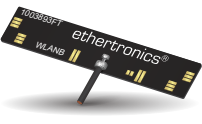

Frequency (GHz)	Peak Gain (dBi)	Efficiency	VSWR	Size L x W x H (mm)	Other
2.400 – 2.485	3.3	87%	< 1.5:1	40.0 x 8.0 x 0.4	Diameter 1.13mm; u.fl compatible connector; Length 100mm using adhesive 3M468

802.11 a/b/g/n/ac/ax / WIFI / WLAN / BLUETOOTH / BLE / WIFI 6 / ZIGBEE APPLICATIONS

W1 FAMILY | Off Board Single Band 2.4 GHz Dipole Antenna



Frequency (GHz)	Peak Gain (dBi)	Efficiency	VSWR (dB)	Size L x W x H (mm)
2.400 – 2.485	2.8	70%	< 1.5:1	35.2 x 8.5 x 0.4
Types	Tuning Versions	Connectors	Cable Lengths (mm)	Mounting Options
PCB FPC	Plastic wall Foam on plastic wall Ribs	u.fl w.fl MHF4	50; 100; 150; 200	Adhesive 3M468MP Adhesive 3M9448A Adhesive 3M467

W2 Family | Off Board Single Band 5 GHz & 6 GHz Dipole Antenna



Frequency (GHz)	Peak Gain (dBi)	Efficiency	VSWR (dB)	Size L x W x H (mm)
5.150 – 5.850	4.3	70%	< 2.1:1	15.9 x 7.6 x 0.4
5.925 – 7.125	3.9		< 2.5:1	
Types	Tuning Versions	Connectors	Cable Lengths (mm)	Mounting Options
PCB FPC	Plastic wall Foam on plastic wall	u.fl w.fl MHF4	50; 100; 150; 200	Adhesive 3M468MP Adhesive 3M9448A Adhesive 3M467

W3 Family | Off Board Dual Band 2.4 GHz, 5 GHz, & 6 GHz Dipole Antenna



Frequency (GHz)	Peak Gain (dBi)	Efficiency	VSWR (dB)	Size L x W x H (mm)
2.400 – 2.485	2.3	70%	< 1.5:1	35.2 x 8.5 x 0.4
5.150 – 5.825	5.0	60%	< 2.0:1	
5.925 – 7.125	2.5	65%	< 3.0:1	
Types	Tuning Versions	Connectors	Cable Lengths (mm)	Mounting Options
PCB FPC	Plastic wall Foam on plastic wall	u.fl MHF4	50; 100; 150; 200	Adhesive 3M468MP Adhesive 3M9448A Adhesive 3M467

WX FAMILY | Off Board Dual Band 2.4 GHz & 5 GHz Dipole Antenna



Frequency (GHz)	Peak Gain (dBi)	Efficiency	VSWR (dB)	Size L x W x H (mm)
2.400 – 2.485	3.0	65%	< 2.1:1	30.0 x 15.5 x 0.8
5.150 – 5.850	6.7	61%		
Types	Tuning Versions	Connectors	Cable Lengths (mm)	Mounting Options
PCB	Plastic wall	u.fl MHF4	50; 100; 150; 200	Adhesive 3M468MP

This antenna is ideal to rotate the radiation patterns with a single mechanical outline, slightly to the left (WA), to the right (WB) and straight aligned with Z axis (WC), which allows to maximize system throughput and migrate peak gain issues.

802.11 a/b/g/n/ac/ax / WIFI / WLAN / BLUETOOTH / BLE / WIFI 6 / ZIGBEE APPLICATIONS



X9001091 Series | External Dual Band Hinged Antenna

Frequency (GHz)	Peak Gain (dBi)	Efficiency	VSWR	Size L x Diameter	Other
2.400 – 2.485	1.8	75%	< 1.5:1	84.00mm x 9.35mm	RPSMA or SMA Connector White & Black
5.150 – 5.850	4.0	80%	< 2.0:1		Performance in free space



X9000294 Series | External Dual Band Hinged Blade Antenna

Frequency (GHz)	Peak Gain (dBi)	Efficiency	VSWR	Size L x Diameter	Other
2.400 – 2.485	3.2	75%	< 1.7:1	157.50mm x 17.65mm	RPSMA or SMA Connector Black
5.150 – 5.850	4.5	60%	< 2.1:1		Performance in free space

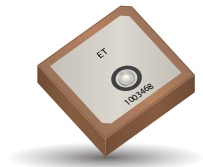

1003468 | 2.4 GHz Ceramic Patch

Frequency (GHz)	Peak Gain (dBi)	Efficiency	VSWR	Size L x W x H (mm)	GND Plane Size (mm)
2.400 – 2.485	3.83	74%	< 2.0:1	18 x 18 x 4	50 x 50



1001435M0 Series | Off Board Dual Band On/Off Ground Stamped Metal Antenna

Frequency (GHz)	Mounting	Peak Gain (dBi)	Efficiency	VSWR	Size L x W x H (mm)	Other
2.400 – 2.485	Off Ground	4.2	82%	< 2.0:1	41.1 x 14.6 x 9.5	GND plane: 150x150mm Diameter: 1.13mm Length: 70mm u.fl connector
	On Ground	4.7	87%			
2500 – 2700	Off Ground	6.4	80%			
	On Ground	6.0	75%			



X1005323 | WiFi External Antenna

Frequency (GHz)	Mounting	Peak Gain (dBi)	Efficiency	VSWR	Size L x W x H (mm)	Other
2400 – 2500	Adhesive Foam	2.5	44%	< 2.0:1	105.1 x 30.1 x 6.7	IPX7; SMA(M) Connector
5150 – 5825	Adhesive Foam	3.3	31%			



X1005324 | LTE MIMO / GNSS (active) / WiFi MIMO 5-in-1 External Antenna

Frequency (GHz)	Mounting	Peak Gain (dBi)	Efficiency	VSWR	Size L x Diameter	Other
2400 – 2485	Adhesive Foam	3.6 / 4.6	62 / 63%	1.8:1 / 1.6:1 max	63.5mm x 141.98mm	IPX7; RP-SMA(M) Connector
5150 – 5825	Adhesive Foam	6.2 / 6.6	51 / 49%	1.8:1 / 1.8:1 max		

802.11 a/b/g/n/ac/ax / WIFI / WLAN / BLUETOOTH / BLE / WIFI 6 / ZIGBEE APPLICATIONS



X1005244 | GNSS (active) / LTE / WiFi 3-in-1 External Antenna

Frequency (GHz)	Mounting	Peak Gain (dBi)	Efficiency	VSWR	Size L x W x H (mm)	Other
2400 – 2500	Foam Adhesive	4.5	61%	2.5:1	136.2 x 72.4 x 12.7	IPX7; RP-SMA(M) Connector
5150 – 5850	Foam Adhesive	3.4	56%	2.0:1		IPX7; RP-SMA(M) Connector

V2X / DSRC APPLICATIONS



X1005248 | GNSS (active) / DSRC 2-in-1 External Antenna

Frequency (GHz)	Mounting	Peak Gain (dBi)	Efficiency	VSWR	Size L x W x H (mm)	Other
5850 – 5920	Adhesive Foam	3.8	54%	< 2.0:1	55.0 x 55.0 x 20.0	IPX5; SMA(M) Connector

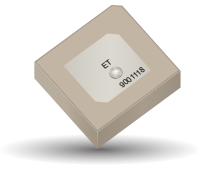

9001118 | Embedded V2X Ceramic Patch Antenna

Frequency (GHz)	Peak Gain (dBi)	Efficiency	VSWR	Polarization	Size L x W x H (mm)	GND Plane Size (mm)
5.850 – 5.925 GHz	4	55%	< 1.5:1	RHCP	13 x 13 x 4	70 x 70



1002298 | Embedded V2X Stamped Metal Antenna (Vertical Position)

Frequency (GHz)	Peak Gain (dBi)	Efficiency	VSWR	Size L x W x H (mm)	GND Plane Size (mm)
5.850 – 5.925	5.1	70%	< 2.0:1	17.95 x 16.1 x 10.55	75 x 75

TEST	MEASUREMENT	OUTPUT
WTS-001 VNA & Anechoic Chamber Testing	Full passive characterization, measurement & analysis of device antenna performance	2D & 3D Radiation Pattern Plots & Composite Maps: <ul style="list-style-type: none"> • Efficiency • Return Loss • ECC • Peak Gain • Composite Gain • Isolation
WTS-002 Octobox Chamber Measurements	Throughput system characterization in a controlled lab environment	Rate vs Range Plots Two tests: One device configuration, two bands
WTS-003 Device Simulation	Indoor propagation simulations for WIFI	Propagation model using a full 3D Ray Tracing Engine Analyze spatial heat maps showing device performance in an indoor environment: <ul style="list-style-type: none"> • Coverage • Throughput • MCS • RSSI
WTS-004 WIFI Test House Measurements	Real-world OTA WIFI system & throughput measurements within one of 3 fully furnished test houses located in France & USA	Benchmark Testing 4 Throughput Tests: One device configuration, two house positions, two bands
WTS-005 Benchmark Testing & Competitive Analysis	Wireless performance analyzed based on throughput data rates, RSSI, spectral efficiency (bps/Hz)	Rate vs Range Analysis Benchmark Testing Comparative Analysis Mapping of performance across test locations
WTS-006 RF Simulations	EM simulation for antenna design	Full antenna characterization in a given environment based on customer request <ul style="list-style-type: none"> • Parametric study • Body loading • Antenna placement • Antenna tuning

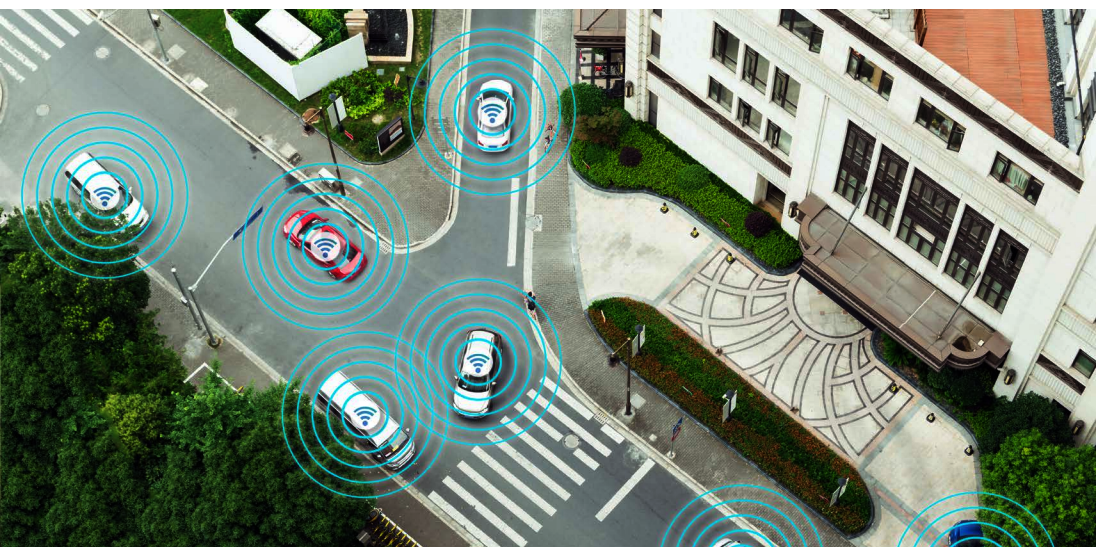

	PART NUMBER	DESCRIPTION	FREQUENCY BANDS
NB-IOT	9000046	External – Indoor	868 MHz; 915 MHz
	M620720	LTCC – SMT	
ISM	1002427	Stamped Metal – SMT	
LoRA	1001011	FR4 – SMT	790 MHz; 868 MHz; 915 MHz
Z-WAVE	X9000984	External – Indoor	
SIGFOX	LSP69001299TR	FR4 – SMT Ideal for small form factor PCB 60x40mm, Middle Feed Point	698 – 960 MHz & 1710 – 2170 MHz
	X1005246	LTE External Antenna	698 – 960 MHz, 1710 – 2170 MHz, 2300 – 2690 MHz, 1710 – 2700 MHz

	PART NUMBER	DESCRIPTION	FREQUENCY BANDS
LTE CAT-M	1004795 / 1004796**	FR4 – SMT	698 – 960 MHz
	P822601 / P822602**		
	1003657	External – Indoor	1710 – 2700 MHz
	1002289	FPC – Off Board	

	PART NUMBER	DESCRIPTION	FREQUENCY BANDS
ISM & 2.4GHz	1002427	Stamped Metal – SMT	915MHz & 2.4GHz
	1002232	FR4 – SMT	868 & 915 MHz, & 2.4GHz

	SMT ON BOARD			OFF BOARD	EXTERNAL
	FR4	METAL	LTTC/CERAMIC	FPC	INDOOR
NB-IoT / ISM LoRA / Z-WAVE SIGFOX	1001011 LSP69001299TR	1002427	M620720		X9000984 9000046
LTE CAT-M	1004795 1004796 P822601 P822602			1002289	1003657
ISM & 2.4 GHZ	1002232	1002427			

**Mirrored parts are used when antenna feed location needs to be reversed

IoT / ISM APPLICATIONS

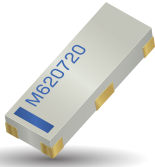

M620720 | 868 MHz & 915 MHz Embedded Ceramic Antenna

Frequency (MHz)	Peak Gain (dBi)	Efficiency	VSWR	Size L x W x H (mm)	GND Plane Size (mm)
863 – 870	0.3	58%	< 1.6:1	6.00 x 2.00 x 1.08	100 x 40
902 – 928	0.75	60%	< 2.5:1		



1002427 | Stamped Metal Embedded SMT Antenna

Frequency (MHz)	Peak Gain (dBi)	Efficiency	VSWR	Size L x W x H (mm)	GND Plane Size (mm)
868 – 915	1.0	62%	< 2.0:1	31.20 x 2.28 x 3.90	110 x 55



X9000984 Series | External Hinged Antenna

Frequency (MHz)	Peak Gain (dBi)	Efficiency	VSWR	Size L x W x H (mm)	GND Plane Size (mm)	Other
790	0.0	> 40%	< 4.4:1	196 x 13	200 x 200	SMA/RP-SMA connectors and black/white colors available
868	2.0	85%	< 1.4:1			
		80%	< 1.6:1			
915	1.5	75%	< 2.0:1			
		82%	< 1.6:1			



9000046-XLPDNB | External ISM Antenna

Frequency (MHz)	Peak Gain (dBi)	Efficiency	VSWR	Size H x Diameter	GND Plane Size (mm)
915	1.0	70%	< 2.0:1	101 mm x 11.16 mm	120



1003657 | External Balanced Antenna

Frequency (GHz)	Peak Gain (dBi)	Efficiency	VSWR	Size L x W x H (mm)
704 – 746	1.0	45%	< 3.0:1	104 x 22 x 4.2
746 – 787	1.6	51%	< 2.0:1	
1710 – 1755	3.2	65%		
2100 – 2155	3.4	79%		



1002427 | Embedded ISM & BT Stamped Metal Antenna

Frequency (MHz)	Peak Gain (dBi)	Efficiency	VSWR	Size L x W x H (mm)	GND Plane Size (mm)
915	3.0	67%	< 2.0:1	31.20 x 2.28 x 3.90	110 x 55
2450	3.4	61%			

IoT / ISM APPLICATIONS



1001011 | Embedded SMT with ISM Band Tuning

Frequency (MHz)	Peak Gain (dBi)	Efficiency	VSWR	Size L x W x H (mm)	GND Plane Size (mm)
868 – 928	1.0	64%	< 2.5:1	22.0 x 3.2 x 3.3	115 x 26.5



1002232 | Embedded Dual Band SMT Antenna

Frequency (MHz)	Peak Gain (dBi)	Efficiency	VSWR	Size L x W x H (mm)	GND Plane Size (mm)
863 – 870	0.5	63%	< 2.0:1	35.0 x 9.0 x 3.2	110 x 50
902 – 928	0.2	60%			
2400 – 2485	1.5	59%			



LSP69001299TR | Embedded FR4 LTE/Cellular Antenna with Centered Feed

Frequency (MHz)	Peak Gain (dBi)	Efficiency	VSWR	Size L x W x H (mm)	GND Plane Size (mm)
698 – 960	< -2	15%	< 7.0:1	35.0 x 9.0 x 3.2	60 x 40
1710 – 2200	< -1.2	42%	< 5.9:1		



X1005246 | LTE External Antenna

Frequency (MHz)	Peak Gain (dBi)	Efficiency	VSWR	Size L x W x H (mm)	Other
698 – 960	2.8	46%	< 1.8:1	105.1 x 30.1 x 6.7	IPX7; SMA(M) Connector
1710 – 2170	3.1	54%	< 1.5:1		
2300 – 2690	2.7	44%	< 2.0:1		



TEST	MEASUREMENT	DELIVERABLE
<p>ITS-001 Passive Testing in Anechoic Chamber</p>	<p>Full characterization, measurement & analysis of passive performance</p> <p>Benchmark testing possible</p>	<p>RF Report:</p> <ul style="list-style-type: none"> • 2D & 3D Radiation Pattern Plots • Efficiency • Return Loss • Peak Gain • Isolation
<p>ITS-002 Antenna Optimization & Passive Testing in Anechoic Chamber</p>	<p>Antenna matching & performance optimization</p> <p>Full characterization, measurement & analysis of passive performance</p>	<p>Matching network for the antenna. PCB footprint. Mechanical recommendations.</p> <p>RF Report:</p> <ul style="list-style-type: none"> • 2D & 3D Radiation Pattern Plots • Efficiency • Return Loss • Peak Gain • Isolation
<p>ITS-003 Active Testing in Anechoic Chamber</p>	<p>Active tests of the full system</p>	<p>RF Report:</p> <ul style="list-style-type: none"> • TRP (CW mode)
<p>ITS-004 LoRa Only Active Testing in Anechoic Chamber</p>	<p>Active tests of the full system</p>	<p>RF Report:</p> <ul style="list-style-type: none"> • TRP • TIS
<p>ITS-005 RF Simulations</p>	<p>EM simulation for antenna design</p>	<p>Full antenna characterization in a given environment based on customer request</p> <ul style="list-style-type: none"> • Parametric study • Body loading • Antenna placement • Antenna tuning

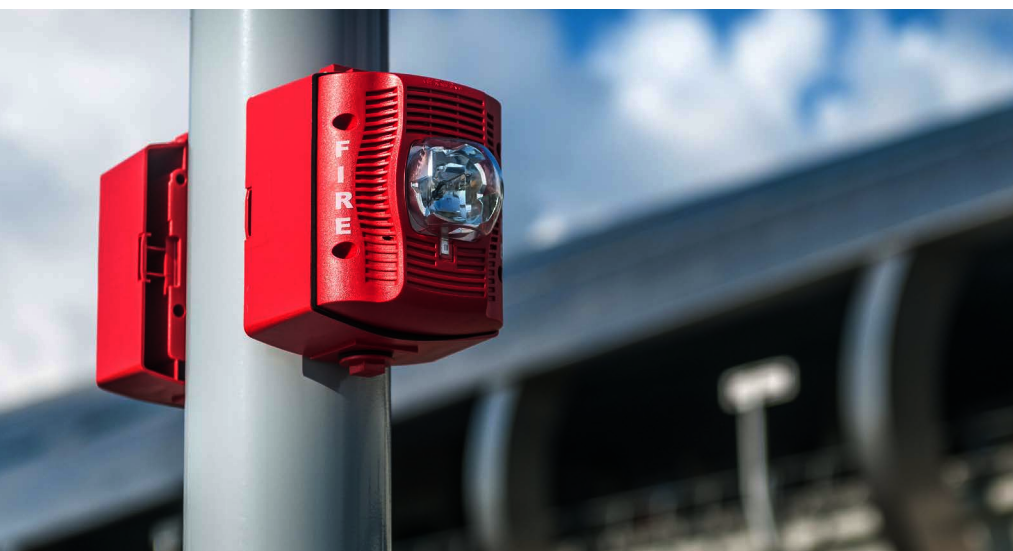

GLOBAL NAVIGATION SYSTEMS GPS; GLONASS; BEIDOU; L-BAND GALILEO; GNSS	PART NUMBER	DESCRIPTION	FREQUENCY BANDS
	1001011	FR4 – SMT	1575 MHz
	1002857 Etherhelix	External – Outdoor IP67	
	1001039	Passive Ceramic Patch – On Board 25x25x4mm	
	1004138	Active Ceramic Patch – Off Board 13x13x7mm & IPX MHF connector	
	9001169	FPC Off Board / Active with LNA & Cable	
	9000440	FPC – Off Board	1560 – 1606 MHz
	M830120	LTCC – SMT	
	1002427	Stamped Metal – SMT	
	1002649	Dual Feed Passive Ceramic Patch – On Board GNSS all bands 25x25x6.7mm	1575 – 1606 MHz
	1004322	Passive Ceramic Patch – On Board GNSS all bands 18x18x4mm	
	1004627	Passive Ceramic Patch 25x25x4mm with Cable & MHF3 connector	
	1004259	Active Ceramic Patch 25x25x6.5mm with Cable & IPX MHF connector	1.606 GHz
	1002429	Passive Ceramic Patch – On Board 25x25x4mm	
	X1005247	GNSS (active) External Antenna	1561 MHz 1575 MHz 1602 MHz
	X1005324	LTE MIMO / GNSS (active) / WiFi MIMO 5-in-1 External Antenna	1561 MHz 1575 MHz 1602 MHz
	X1005245	GNSS (active) / LTE MIMO 3-in-1 External Antenna	1561 MHz 1575 MHz 1602 MHz
	X1005244	GNSS (active) / LTE / WiFi 3-in-1 External Antenna	1561 MHz 1575 MHz 1602 MHz
	X1005243	GPS/GLONASS (Active) & LTE 2-in-1 External Antenna	1575 MHz 1602 MHz
	X1005249	GPS/GLONASS (active) & LTE 2-in-1 External Antenna	1575 MHz 1602 MHz
X1005248	GNSS (active) / DSRC 2-in-1 External Antenna	1561 MHz 1575 MHz 1602 MHz	

		SMT ON BOARD			OFF BOARD	EXTERNAL
		FR4	METAL	LTCC/CERAMIC	FPC	OUTDOOR
GLOBAL NAVIGATION SYSTEMS	PASSIVE	1001011	1002427	1001039 1002649 1004322 1002429 1004627 M830120	9000440	1002857 X1005247 X1005324
	ACTIVE			1004138 1004259	9001169	X1005245 X1005244 X1005243 X1005249 X1005248

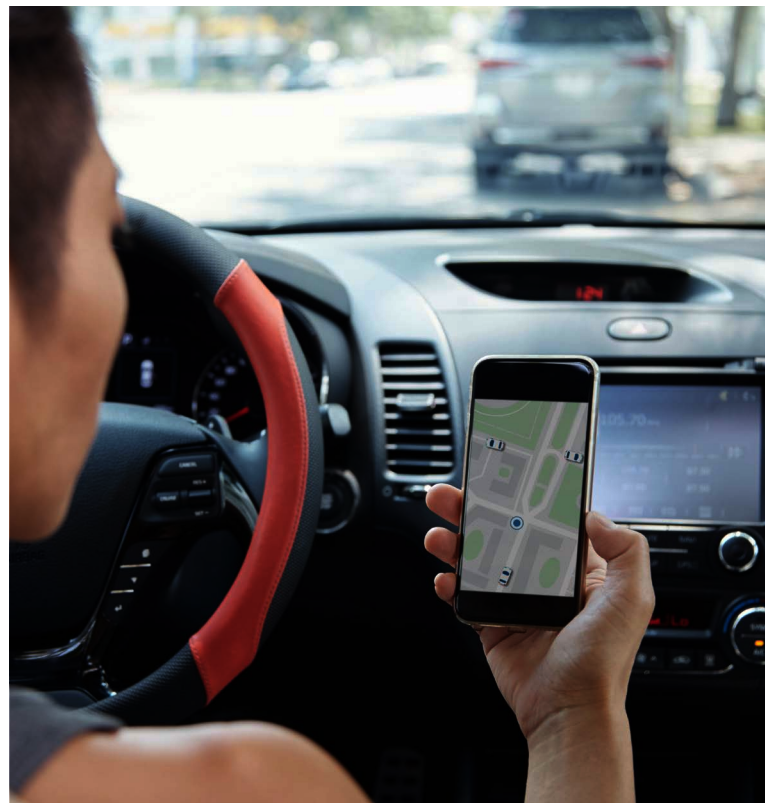

GLOBAL NAVIGATION APPLICATIONS

1001011 | Embedded On/Off Ground FR4 Antenna (GPS / GLONASS / BeiDou / Galileo)



Frequency (GHz)	Mounting	GNSS Bands	Peak Gain (dBi)	Efficiency	VSWR	Size L x W x H (mm)	GND Plane Size
1.559 – 1.563	On Ground	BeiDou	1.0	72%	< 1.5:1 / < 2.5:1	22.0 x 3.2 x 3.3	72 mm x 50 mm
			-0.3	47%			
1.575	Off Ground	GPS	0.9	71%			
			-0.2	46%			
1.559 – 1.591	On Ground	Galileo	1.0	70%			
			-0.2	45%			
1.593 – 1.610	Off Ground	GLONASS	1.0	69%			
			-0.4	41%			

M830120 | Embedded Ceramic Antenna (Tuning for GPS / GLONASS / BeiDou / Galileo)



Frequency (GHz)	GNSS Bands	Peak Gain (dBi)	Efficiency	VSWR	Size L x W x H (mm)	GND Plane Size (mm)
1.559 – 1.563	BeiDou	1.8	70%	< 2.0:1	8.00 x 3.00 x 1.33	80 x 40
1.575	GPS	1.9	73%			
1.559 – 1.591	Galileo	1.9	70%			
1.593 – 1.610	GLONASS	1.7	62%			

M830120 | Embedded Ceramic Antenna (Tuning for L1 / L2 / L5)



Frequency (GHz)	GNSS Bands	Peak Gain (dBi)	Efficiency	VSWR	Size L x W x H (mm)	GND Plane Size (mm)
1575.42	L1	2.7	80%	< 2.0:1 < 2.5:1 < 2.5:1	8.00 x 3.00 x 1.33	90 x 40
1227.6	L2	2.8	76%			
1176.45	L3	2.7	77%			

1002427 | Embedded Stamped Metal SMT Antenna (GPS)



Frequency (GHz)	Peak Gain (dBi)	Efficiency	VSWR	Size L x W x H (mm)	GND Plane Size (mm)
1.560 – 1.606	1.8	65%	< 2.0:1	31.20 x 2.28 x 3.90	110 x 55

1002857 | EtherHelix™ Mission Critical External Antenna (GPS)



Frequency (GHz)	Peak Gain (dBi)	Efficiency	VSWR	Beam Width	Size H x Diameter
1.575	-3.0 (-5.0 @ Zenith)	27%	< 2.0:1	120° (Axial Ratio < 3dB)	34.93 mm x 15.00 mm

1004322 | Passive Ceramic Patch Antenna (GPS / GLONASS / BeiDou / Galileo)



Frequency (GHz)	GNSS Bands	Peak Gain (dBi)	Center Frequency	VSWR	Polarization	Size L x W x H (mm)	GND Plane Size
1.559 – 1.563	BeiDou	3.9	1.561 GHz	3.5:1	RHCP	18.0 x 18.0 x 4.7	70 x 70 mm
1.575	GPS	1.6	1.575 GHz	2.8:1			
1.559 – 1.591	Galileo	1.6		3.8:1			
1.593 – 1.610	GLONASS	1.6	1.603 GHz	2.2:1			

GLOBAL NAVIGATION APPLICATIONS

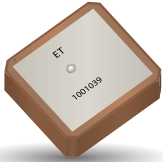

1001039 | Passive Ceramic Patch Antenna (GPS)

Frequency (GHz)	Peak Gain (dBi)	VSWR	Polarization	Axial Ratio (dB)	Size L x W x H (mm)	GND Plane Size (mm)
1.575	5.3	< 1.3:1	RHCP	1.8	25 x 25 x 4.5	70 x 70

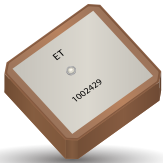

1002429 | Passive Ceramic Patch Antenna (GLONASS)

Frequency (GHz)	Peak Gain (dBi)	Efficiency	VSWR	Polarization	Axial Ratio	Size L x W x H (mm)	GND Plane Size
1.593 – 1.610	6.5	70%	< 1.4:1	RHCP	< 3 dB	25 x 25 x 4.5	60 mm x 60 mm



1002649 | Passive Antenna with Dual Feed (GPS / GLONASS / BeiDou / Galileo)

Frequency (GHz)	GNSS Bands	Peak Gain (dBi)	Center Frequency	VSWR	Polarization	Size L x W x H (mm)	GND Plane Size
1.559 – 1.563	BeiDou	3.8	1.561 GHz	< 3.5:1	RHCP	18.0 x 18.0 x 4.7	70 x 70 mm
1.575	GPS	3.1	1.575 GHz	< 2.8:1			
1.559 – 1.591	Galileo	4.0		< 3.8:1			
1.593 – 1.610	GLONASS	3.9	1.603 GHz	< 2.2:1			



1004627 | Passive Ceramic Patch with Cable & MHF4 Connector (GPS / GLONASS)

Frequency (GHz)	Gain 0° (dBic)	Efficiency	VSWR	Polarization	Axial Ratio (dBi)	Size L x W x H (mm)	GND Plane Size (mm)
1.575	3.6	60%	< 2.0:1	RHCP	1.0	25 x 25 x 5.3	70 x 70
1.602	1.0	36%	< 3.0:1		8.0		



1004259 | Active GPS Ceramic Patch Antenna with Cable

Frequency (GHz)	Peak Gain	Efficiency	Oper. Volt	Polarization	LNA/FilterGain	Size L x W x H (mm)	Other
1.575	5.0 dBi	79%	3.0 ± 0.1 V	RHCP	20 ± 3 dB	25 x 25 x 6.5	Using MHF connector, diameter 1.13 mm cable & 76 mm length
1.602							

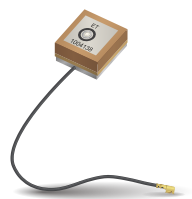

1004138 | Active GPS Ceramic Patch Antenna with LNA and Cable

Frequency (GHz)	Peak Gain	Bandwidth	Oper. Volt	Polarization	LNA/FilterGain	Size L x W x H (mm)	Other
1.575	1.0 dBi	10 MHz min.	3.0 ± 0.1 V	RHCP	21 ± 3 dB	13 x 13 x 6.8 mm	Using MHF connector, Diameter 1.13 mm cable & 126 mm length

GLOBAL NAVIGATION APPLICATIONS

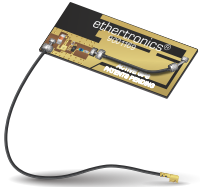

9001169 | Active FPC Based Antenna (GPS)

Frequency (GHz)	Gain (dBi)	Efficiency	Polarization	Radiation Pattern	Cable Length (mm)	Size L x W x H (mm)
1.559 – 1.591	at 3.30V: 15.81 at 2.70V: 15.72 at 1.80V: 14.84	55%	Linear	Omni directional	100mm; 1.13 diameter; u.fl connector	41.0 x 15.5 x 0.2



9000440 | Passive FPC Based Antenna (GPS)

Frequency (GHz)	Peak Gain (dBi)	Efficiency	VSWR	Cable Length (mm)	Size L x W x H (mm)
1575	2.0	45%	< 10:1	150mm; 1.13 diameter; u.fl connector	41 x 15.5 x 2.2



X1005247 | GNSS (active) External Antenna

Frequency (MHz)	Peak Gain (dBi)	LNA Filter Gain	VSWR	Size L x W x H (mm)	Other
1561 1575 1602	2.0 4.1 2.0	28 dB / 25 dB min.	< 2.0:1	44.0 x 35.2 x 14.5	IPX7; SMA(M) Connector



X1005324 | LTE MIMO / GNSS (active) / WiFi MIMO 5-in-1 External Antenna

Frequency (MHz)	Peak Gain (dBi)	LNA Filter Gain	VSWR	Size L x Diameter	Other
1561 1575 1602	3.0 3.0 3.5	28 dB / 25 dB min.	< 2.0:1	63.5mm x 141.98mm	IPX7; SMA(M) Connector



X1005245 | GNSS (active) / LTE MIMO 3-in-1 External Antenna

Frequency (MHz)	Peak Gain (dBi)	LNA Filter Gain	VSWR	Size L x W x H (mm)	Other
1561 MHz 1575 MHz 1602 MHz	1.1 2.1 2.3	28 dB / 25 dB min.	< 2.0:1	136.2 x 72.4 x 12.7	IPX7; SMA(M) Connector

GLOBAL NAVIGATION APPLICATIONS



X1005244 | GNSS (active) / LTE / WiFi 3-in-1 External Antenna

Frequency (MHz)	Peak Gain (dBi)	LNA Filter Gain	VSWR	Size L x W x H (mm)	Other
1561 MHz	1.1	28 dB / 25 dB min.	3.0:1	136.2 x 72.4 x 12.7	IPX7; SMA(M) Connector
1575 MHz	2.1		3.0:1		
1602 MHz	2.3		3.0:1		



X1005243 | GPS/GLONASS (Active) & LTE 2-in-1 External Antenna

Frequency (MHz)	Peak Gain (dBi)	LNA Filter Gain	VSWR	Size L x Diameter	Other
1575 MHz	1.0	28 dB / 25 dB min.	< 2.0:1	51.4mm x 10.5mm	IPX5; SMA(M) Connector
1602 MHz	1.0				



X1005249 | GPS/GLONASS (active) & LTE 2-in-1 External Antenna

Frequency (MHz)	Peak Gain (dBi)	LNA Filter Gain	VSWR	Size L x W x H (mm)	Other
1575 MHz	3.0	28 dB / 25 dB min.	< 2.0:1	55.0 x 55.0 x 20.0	IPX5; SMA(M) Connector
1602 MHz	3.5				



X1005248 | GNSS (active) / DSRC 2-in-1 External Antenna

Frequency (MHz)	Peak Gain (dBi)	LNA Filter Gain	VSWR	Size L x W x H (mm)	Other
1561 MHz	2.0	28 dB / 25 dB min.	< 2.0:1	55.0 x 55.0 x 20.0	IPX5; SMA(M) Connector
1575 MHz	3.0				
1602 MHz	3.5				

TEST	MEASUREMENT	DELIVERABLE
<p>GTS-001 Passive Testing in Anechoic Chamber</p> <p>GTS-001A Passive Testing in Automotive Chamber</p>	<p>Full characterization, measurement & analysis of passive antenna performance</p> <p>Benchmark testing possible</p>	<p>RF Report:</p> <ul style="list-style-type: none"> • 2D & 3D Radiation Pattern Plots • Efficiency • Return Loss • Peak Gain • Isolation
<p>GTS-002 Antenna Optimization & Passive Testing in Anechoic Chamber</p> <p>GTS-002A Antenna Optimization & Passive Testing in Automotive Chamber</p>	<p>Antenna matching & performance optimization</p> <p>Full characterization, measurement & analysis of passive antenna performance</p>	<p>Matching network for the antenna. PCB footprint. Mechanical recommendations.</p> <p>RF Report:</p> <ul style="list-style-type: none"> • 2D & 3D Radiation Pattern Plots • Efficiency • Return Loss • Peak Gain • Isolation
<p>GTS-003 Active Field Test</p>	<p>Active tests of the full system</p>	<p>RF Report:</p> <ul style="list-style-type: none"> • Number of satellites detected • Field test sensitivity • RF measurement of full system LNA/antenna
<p>GTS-004 RF Simulations</p>	<p>EM simulation for antenna design</p>	<p>Full antenna characterization in a given environment based on customer request</p> <ul style="list-style-type: none"> • Parametric study • Body loading • Antenna placement • Antenna tuning



UWB	PART NUMBER	DESCRIPTION	FREQUENCY BANDS (GHz)
	1001312	LTCC-SMT	6.0 – 8.5
	1005188F0	FPC-off Board	6.0 – 8.5
	1005190F0	FPC-off Board	6.5 – 8.5
	1005193	FR4-off Board with SMA Connector	6.0 – 8.5
	1005194	FR4-off Board with SMA Connector	6.0 – 8.5

	SMT ON BOARD	OFF BOARD	
	LTCC	FR4	FPC
UWB	1001312	1005193	1005188F0
		1005194	1005190F0

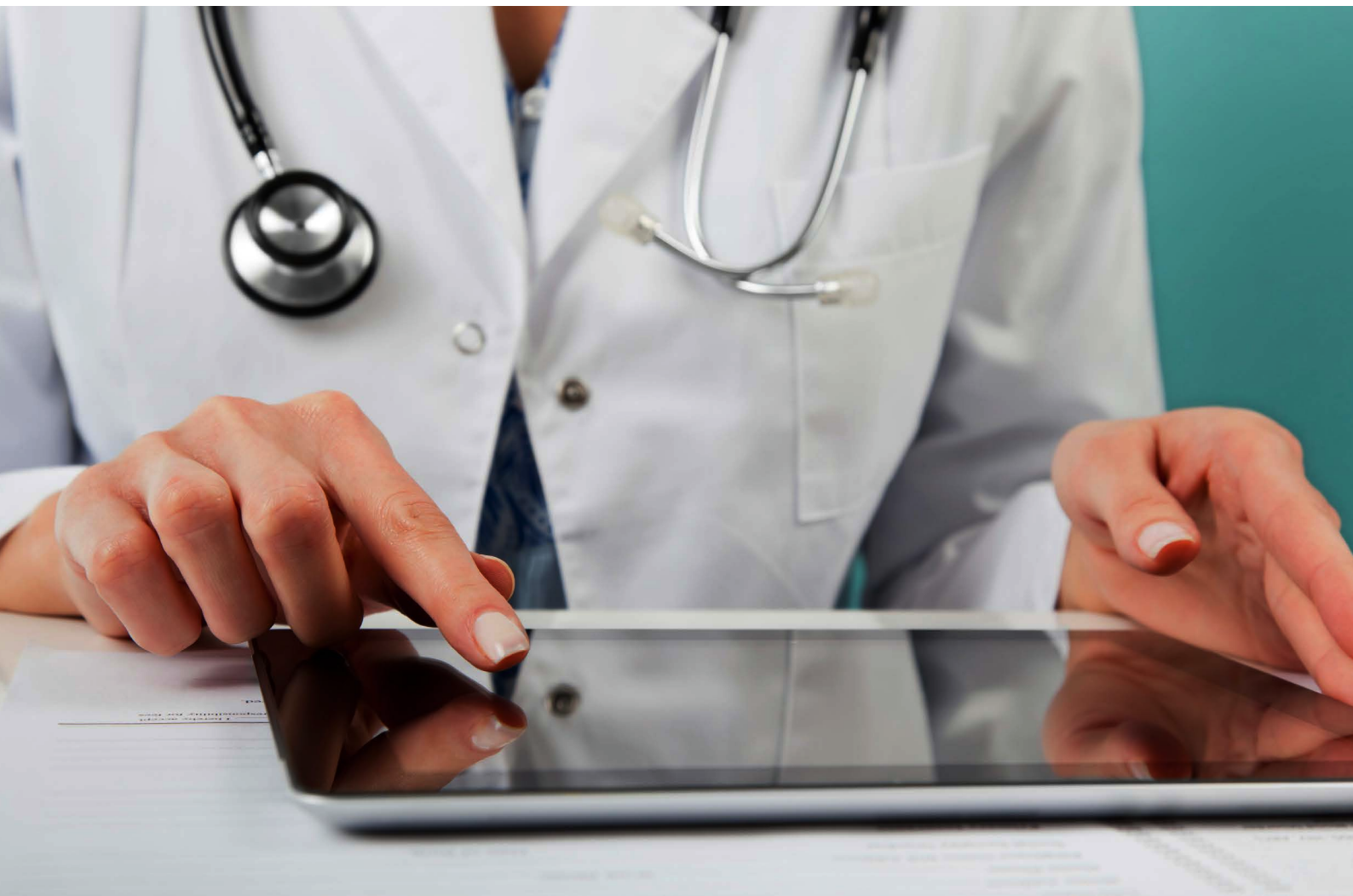

ULTRA WIDE BAND (UWB) APPLICATION

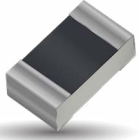

1001312 | Embedded LTCC UWB Antenna

Frequency (GHz)	Peak Gain (dBi)	Efficiency	VSWR	Size L x W x H	Board
6.0 – 8.5	4.8	84%	< 2.0:1	2.00 x 1.20 x 0.55	26.0 x 25.0



1005188F0 | UWB FPC off Board Antenna

Frequency (GHz)	Peak Gain (dBi)	Efficiency	VSWR	Size L x W x H
6.0 – 8.5	5.2	82%	< 2.0:1	15.6 x 18.6 x 0.2

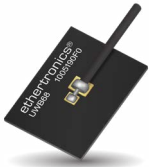

1005190F0 | UWB FPC off Board Antenna

Frequency (GHz)	Peak Gain (dBi)	Efficiency	VSWR	Size L x W x H
6.5 – 8.5	5.3	85%	< 2.0:1	18.6 x 15.6 x 0.2



1005193 | UWB FR4 Antenna with SMA connector

Frequency (GHz)	Peak Gain (dBi)	Efficiency	VSWR	Size L x W x H
6.0 – 8.5	6.0	80%	< 2.0:1	18.6 x 20.6 x 0.8



1005194 | UWB FR4 Antenna with SMA connector

Frequency (GHz)	Peak Gain (dBi)	Efficiency	VSWR	Size L x W x H
6.0 – 8.5	6.1	85%	< 2.0:1	20.6 x 18.6 x 0.8



TEST	MEASUREMENT	DELIVERABLE
<p>UTS-001 Passive Testing in Anechoic Chamber</p>	<p>Full characterization, measurement & analysis of passive antenna performance</p> <p>Benchmark testing possible</p>	<p>RF Report:</p> <ul style="list-style-type: none"> • 2D & 3D Radiation Pattern Plots • Efficiency • Return Loss • Peak Gain • Isolation
<p>UTS-002 Antenna Optimization & Passive Testing in Anechoic Chamber</p>	<p>Antenna matching & performance optimization</p> <p>Full characterization, measurement & analysis of passive performance</p>	<p>Matching network for the antenna. PCB footprint. Mechanical recommendations.</p> <p>RF Report:</p> <ul style="list-style-type: none"> • 2D & 3D Radiation Pattern Plots • Efficiency • Return Loss • Peak Gain • Isolation
<p>UTS-003 RF Simulations</p>	<p>EM simulation for antenna design</p>	<p>Full antenna characterization in a given environment based on customer request</p> <ul style="list-style-type: none"> • Parametric study • Body loading • Antenna placement • Antenna tuning

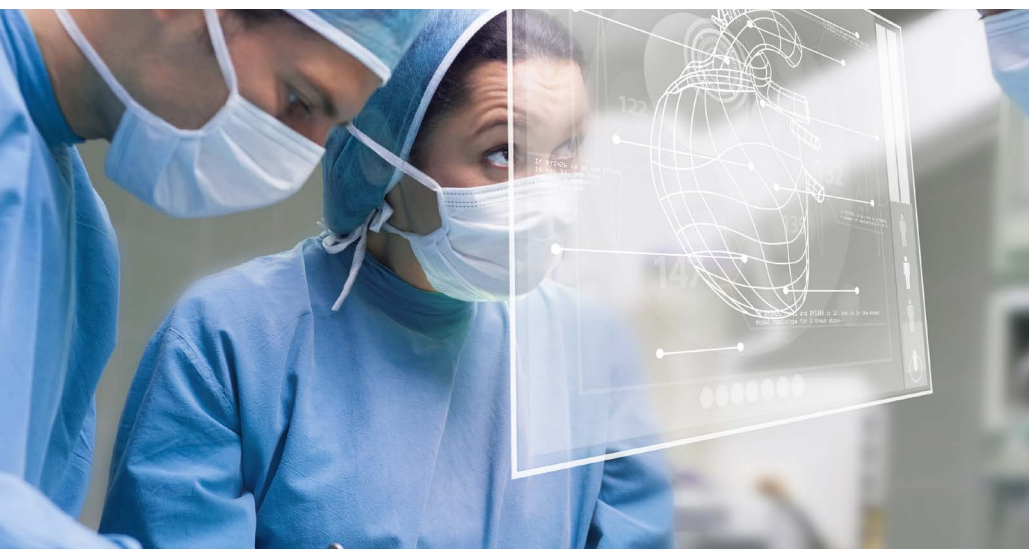

The ETH-MMW-1000 is a full anechoic millimeter wave measurement system capable of passive and active testing of wireless devices from 18 to 110GHz. KYOCERA AVX is one of the only antenna companies able to provide 5G antenna measurement systems for this range. This system is self-contained, movable, and compact enough to fit into any laboratory or production environment.

Several KYOCERA AVX locations are equipped with the ETH-MMW-1000 and are able to provide local testing services in the Americas, EMEA, and Asia. Active signaling measurements require an emulator such as ANRITSU MT8000A and MT8821C, but Keysight or R&S equipment is also compatible.

DEVICE SPECIFICATIONS

- Dimensions: 1.56m L x 1.24m W x 2.13m H
- Chamber frame: Aluminum
- Max DUT dimensions: 45 cm
- Max DUT weight: 10 Kg
- Total equipment weight: 430 Kg without VNA
- Positioners: 0-180° & 0-360°, accuracy 0.01°

Please visit www.kyocera-avx.com for additional information and the value proposition.

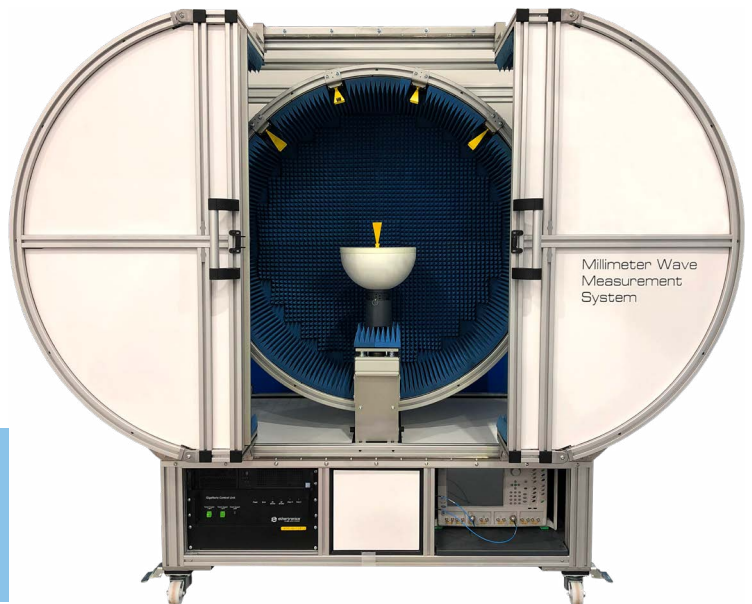

MEASUREMENT CAPABILITIES

- Gain
- Directivity
- Efficiency
- Beam width
- Cross polar discrimination
- Side lobe levels
- 3D radiation pattern
- Radiation pattern in any polarization
- TRP, TIS, EIRP & EIS

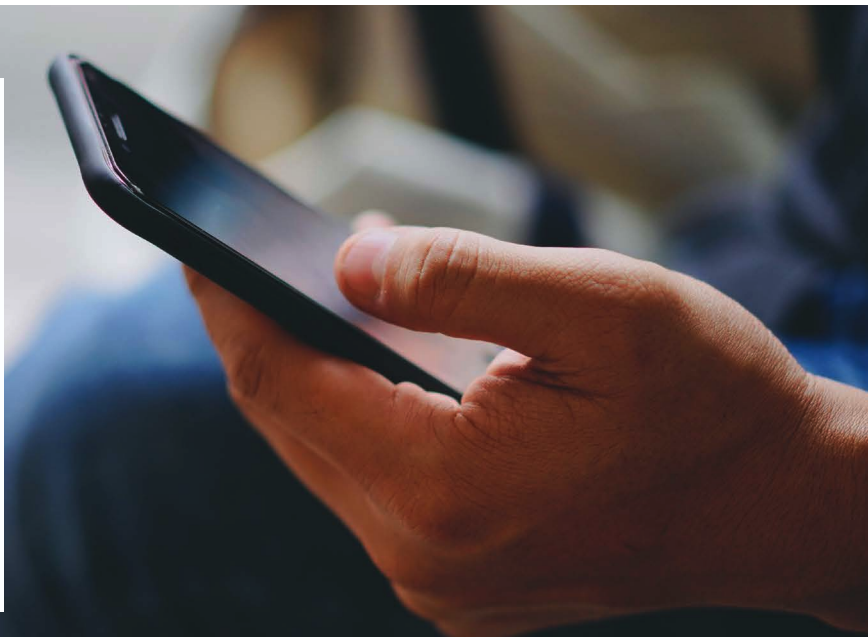

TEST	MEASUREMENT	DELIVERABLE
mmWTS-001 Passive Testing Fixed Array Configuration	Full characterization, measurement & analysis of passive antenna performance	RF Report: <ul style="list-style-type: none"> • Directivity/Gain • Efficiency • Beam width • Cross polar discrimination • Side lobe levels • 3D Radiation Pattern
mmWTS-002 Passive Testing Beamforming Array Configuration	Full characterization, measurement & analysis of passive antenna performance	RF Report: <ul style="list-style-type: none"> • Directivity/Gain • Efficiency • Beam width • Cross polar discrimination • Side lobe levels • 3D Radiation Pattern
mmWTS-003 5G Non-signaling Active Testing	TRP testing with CW signal	Measurement of power radiation patterns
mmWTS-004 5G Signaling Active Testing	TRP/TIS testing with 5G emulator <i>Dependent upon availability of local third-party equipment</i>	Measurement of power radiation patterns
mmWTS-005 5G mmWave Chamber Rental	Includes logistics, setup, tear down & operator training	4 Week rental of 5G mmWave chamber

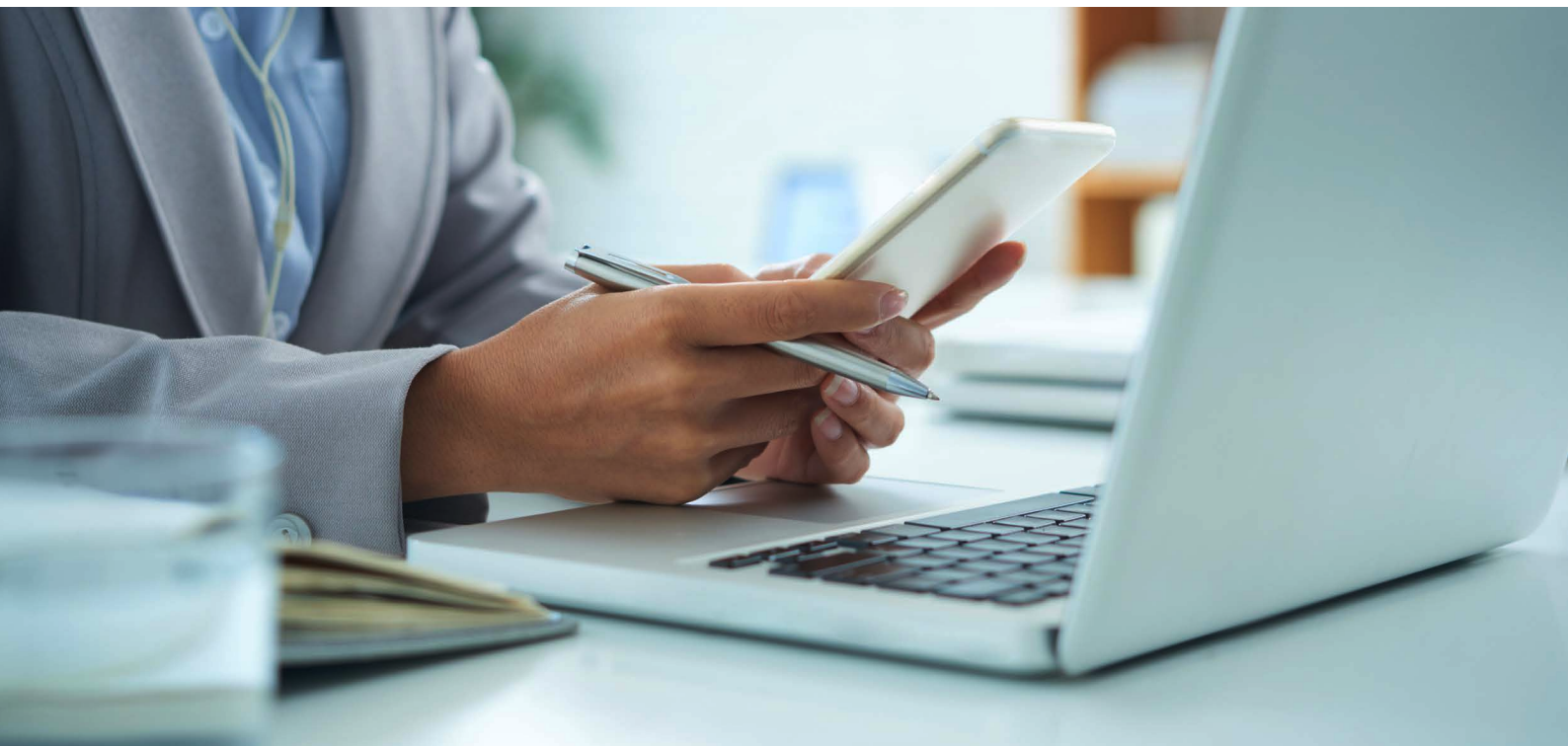

KYOCERA AVX PART NUMBER	MODULE	MODULE MANUFACTURER	MODULE MANUFACTURER DISTRIBUTOR
M620720	MultiConnect® xDot™	MultiTech	DigiKey, Future Electronics
EC477 / EC624	Broadcom 4366E	BROADCOM 4x4 MIMO dual band w/off board active steering antennas	
1001932PT/1001932FT	ConnectCore 6®	DIGI® International	Mouser, DigiKey, Arrow, Avnet
1000146; 1001932PT/1001932FT	ConnectCore® 6UL SBC Express board	DIGI® International	Mouser, DigiKey, Arrow, Avnet
1000423	ThermoFisher Scientific W1001 Module	Fisher Scientific™	ThermoFisher Scientific
1000146	Laird™ WB45NBT	Laird™	Mouser, DigiKey, Arrow, Avnet, Future Electronics
1000146	Laird™ 60-SIPT	Laird™	Mouser, DigiKey, Arrow, Avnet, Future Electronics
P822601; 1002436; 1002289	u-blox SARA-R4	u-blox	DigiKey, Richardson RFPD
1000418	Extron Transceiver 20-2052-01LF	Extron	Extron
1002292	Multitech Dragon Fly	MultiTech	Future Electronics, DigiKey
P822601	Nordic Semiconductor nRF91 SiP	Nordic Semiconductor	Rutronik, Farnell, Avnet, DigiKey, Mouser
P822601	Nordic nRF9160 Dev Kit	Nordic Semiconductor	Rutronik, Farnell, Arrow, Avnet, DigiKey, Mouser
M830520	Lantronix Premier Wave SE1000	Lantronix	Mouser, Symmetry, Arrow, Richardson RFPD
M830520	Lantronix Premier Wave EN	Lantronix	Mouser, Symmetry, Arrow, Richardson RFPD
1001077; 1000668	Lantronix xPICO	Lantronix	Mouser, Symmetry, Arrow, Richardson RFPD
1000423	TI WL1835MOD	Texas Instruments	Mouser, Avnet, DigiKey, Arrow
1000423	TI WL1831MOD	Texas Instruments	Mouser, Avnet, DigiKey, Arrow
1000423	TI WL1805MOD	Texas Instruments	Mouser, Avnet, DigiKey, Arrow
1000423	TI WL1801MOD	Texas Instruments	Mouser, Avnet, DigiKey, Arrow
1000423	TI WL1837MOD	Texas Instruments	Mouser, Avnet, DigiKey, Arrow
1000423	TI WL1807MOD	Texas Instruments	Mouser, Avnet, DigiKey, Arrow
M830520; M830520	TI Simplelink CC3225MOD	Texas Instruments	Mouser, Avnet, DigiKey
1001312	Telit WE866C3-I	Telit	Rutronik, Arrow
M830120	Telit SL876Q5-A	Telit	Rutronik, Arrow
M830520	Premier Wave 2050	Lantronix US	Mouser
M830520	Midatronics	Sharky Pro Italy	Midatronics

ACTIVE STEERING™

Active Steering™ antenna systems boost wireless connectivity significantly. This patented technology continually optimizes the antenna's direction in real-time on a per-millisecond basis, creating multiple radiation patterns around the same antenna, and then selects the ideal pattern to hit its targeted device with the best signal.

The result is a major increase in range, reliability, and speed between devices living on the fringes of a network or hidden behind walls and hard-to-reach spaces.



Passive Omni Directional Antennas
Are not 100% Omni Directional



Passive Antennas
Have "null" areas of low emissions



Active Antennas
Eliminate nulls by "steering" the emission in real-time by using intelligent algorithms and flexible antenna structure

KYOCERA AVX ACTIVE STEERING SYSTEM COMPETITIVE ADVANTAGE



~50-100%

More Throughput/Speed
Significantly faster downloads



~60-120%

More Spectral Efficiency
Increased network capacity



6dB SINR

More Reliability
Interference mitigation



4x

More Performance
Maximized signal strength

IMPEDANCE MATCHING

Impedance matching technology enables the possibility to retune an antenna system (automatically in an open loop or closed loop based design) using pre-determined look-up tables or RSSI analysis based on a patented algorithm.

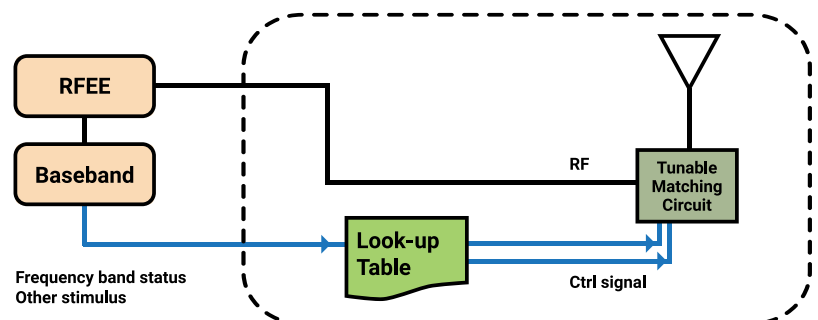

BAND SWITCHING

With design complexity increasing every day, KYOCERA AVX's patented RF band switching technology is ideal for meeting harsh specifications when the environment reduces the original bandwidth. The reduction could be caused by the presence of metallic components, wires, harnesses, heatsink, other antennas, LCD, shielding cans, PCB grounding and connectors. Typical band switching architectures use 4 switching states in the low band operations and one state in the high band.

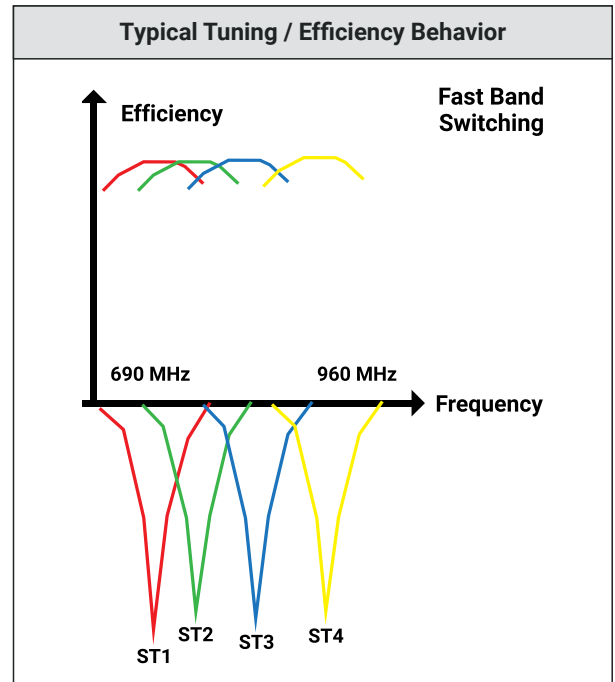
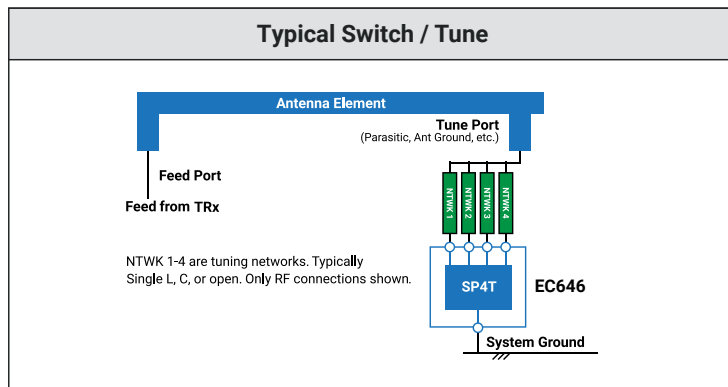

ACTIVE COMPONENTS FOR BAND SWITCHING

Active switching technology benefits include: longer range, higher throughput and broader signal coverage. Connection dead spots are reduced as the RF switch and antenna are designed together, allowing for a more flexible antenna system placement and development in the device. Link optimization is obtained through a band switching concept that allows simpler and smaller antenna architecture to cover a wider bandwidth.

EtherChip EC646™ | High Performance SP4T Antenna



The EC646™ is a high performance shuntless SP4T ideal for band switching applications. This device can be used in a variety of applications including: cell phones, tablets, notebooks, M2M products, IoT products, other wireless devices. Its operating frequency range is from 100MHz to 3GHz, using a shuntless architecture with a low RON of 1.2Ω and an exceptional linearity of >+80dBm (IIP3). The total package is 1.1 x 1.5 x 0.5mm³ using a 10 package and 2pin GPIO control interface.

UPCOMING PRODUCT RELEASES

By continuing to invest heavily in R&D and submitting several new patent applications every year, KYOCERA AVX continues to further expand the company's strong technology base with newly innovative, next-generation product solutions. Below is a list of products currently in development for release.

SAMPLE KITS

- FPC antennas
- LTE Cat-M / NB-IoT
- UWB

5G ANTENNAS & FEMs

- 28 GHz full front end module
- 28 GHz passive antenna array
- Sub-6 GHz passive antenna array
- Subgiga 5G bands (FPC and FR4)

COMBO ANTENNAS (INTERNAL TYPES)

- MIMO 2x2 WIFI & WIFI 6 dual band FPC and 2 cables
- MIMO 3x3 WIFI & WIFI 6 dual band FPC and 3 cables
- MIMO 4x4 WIFI & WIFI 6 dual band FPC and 4 cables
- MIMO 2x2 4G and GPS, FPC with 3 cables
- MIMO 2x2 4G and WIFI, FPC with 3 cables
- ISM 868/915 + GPS + WIFI FPC with 3 cables
- ISM 868/915 + GPS + 4G FPC with 3 cables
- 600 MHz side and middle cable FPC type
- All bands LTE blade antenna with TNC

ISM ANTENNAS

- 915 MHz patch
- 868 MHz patch
- 433 MHz external directive antenna

SATCOM ANTENNAS

- S-band antenna
- L-band antenna patch antenna (non-ceramic)
- Stacked patches (L1/L2)
- Multi-band GNSS active antenna (L1/L2/L5)
- 400MHz CP low orbit antenna

MULTIBAND EXTERNAL ANTENNAS (IP67)

- 1 inch thickness, 6-in-1 (2x4G, 3x WIFI, 1x GNSS), 6 cables
- High performance, 6-in-1 (2x4G, 3xWIFI, 1xGNSS), 6 cables
- Cost efficient rugged mag mount 4G antenna
- Cost efficient rugged mag mount MIMO 2x2 4G antenna
- Sharkfin antenna
- Fiberglass WIFI dual band antenna
- Fiberglass 2.4 GHz antenna

For the most up-to-date product releases and product information, please visit WWW.KYOCERA-AVX.COM

NORTH AMERICA
Tel: +1-864-967-2150

CENTRAL AMERICA
Tel: +55-11-46881960

EUROPE
Tel: +44-1276-697000

ASEAN / INDIA / TAIWAN
Tel: +65-6271-0500

CHINA
Tel: +86-21-5877-5366 *511

JAPAN
Tel: +81-75-604-3640

KOREA
Tel: +82-2-3463-3538

WWW.KYOCERA-AVX.COM

